

# INSTALLATION MANUAL

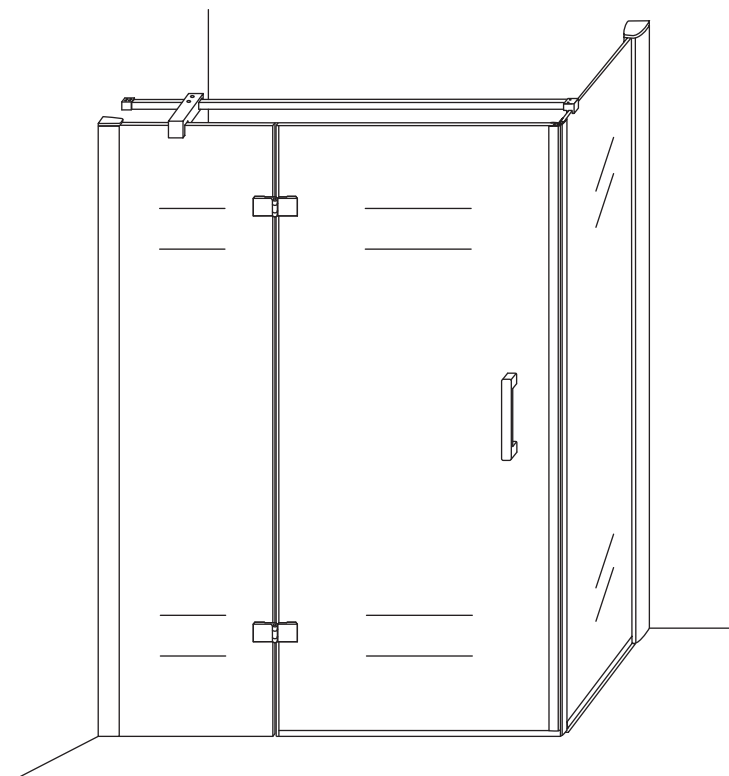

**RoHS** **CE** **ISO9001:2000**

# TOOL PICTURE

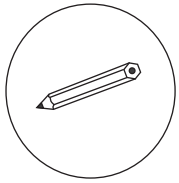

Pencil

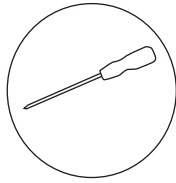

Cross screw driver

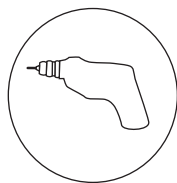

Drill machine

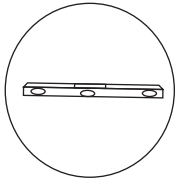

Level ruler

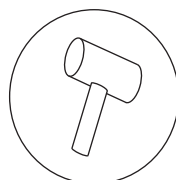

Rubber hammer

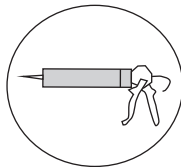

Silicon gel

## Accessory list

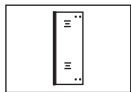

Glass

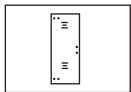

Glass



Glass

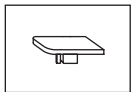

PJ-4509

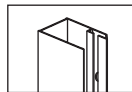

Wall profile

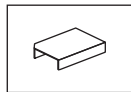

PJ-4733

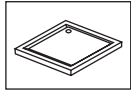

Tray

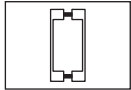

LS-1105



PJ-4577



CT-6BMX90

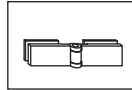

HY3109

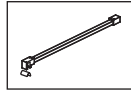

LG-2307

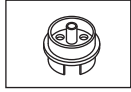

PJ-4126

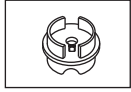

PJ-4127

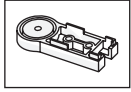

PJ-4124

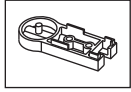

PJ-4125

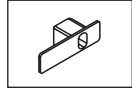

PJ-4649

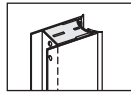

LJ-02



5x12

Screw

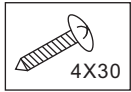

4X30

Screw

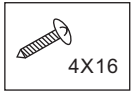

4X16

Screw

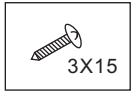

3X15

Screw

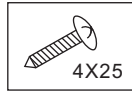

4X25

Screw

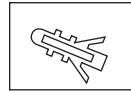

Expand tube

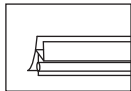

water-proof gasket

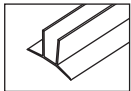

water-proof gasket

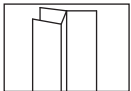

water-proof gasket

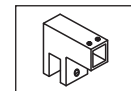

Alternative gasket

4. Use silicon gel to seal the gap between fixed glass

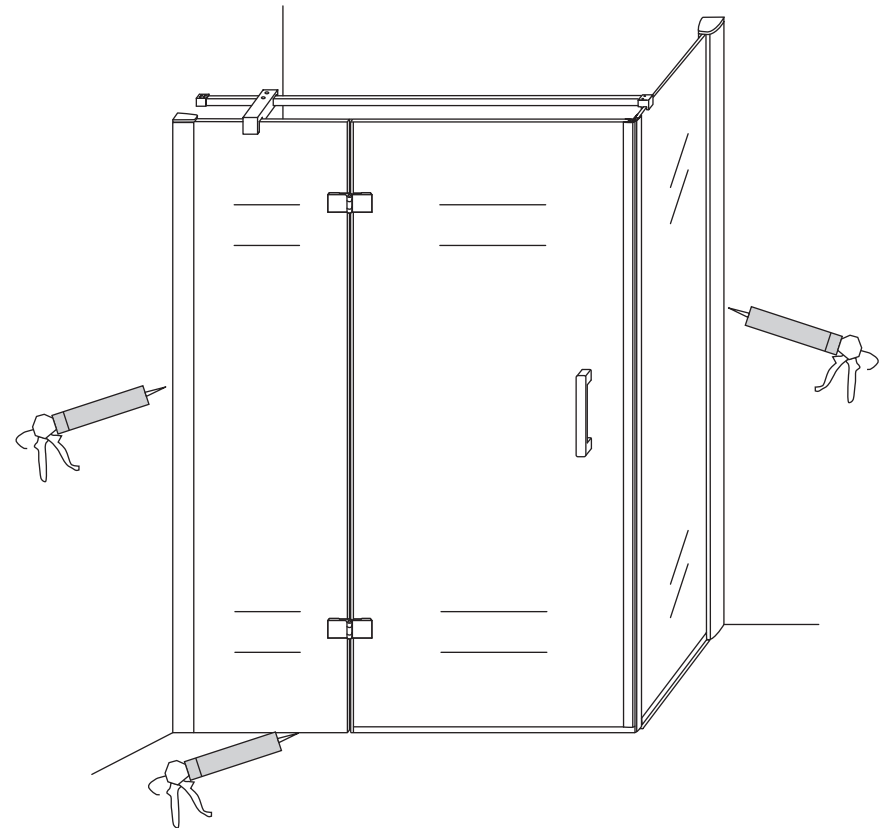

Install the support bar.

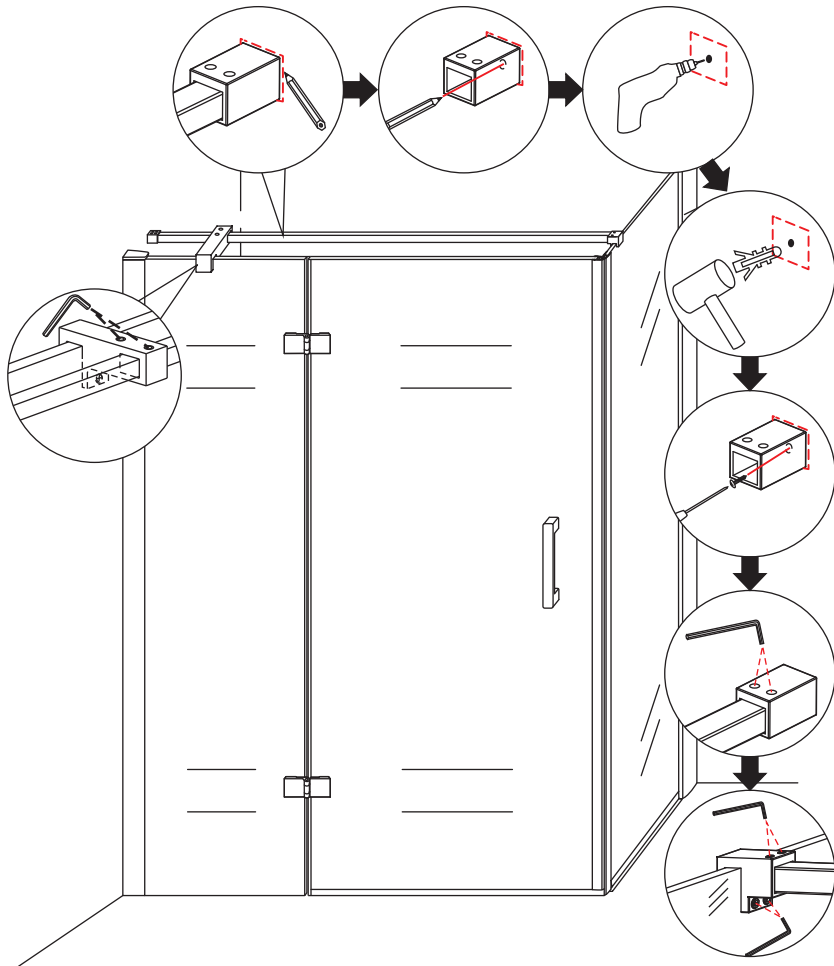
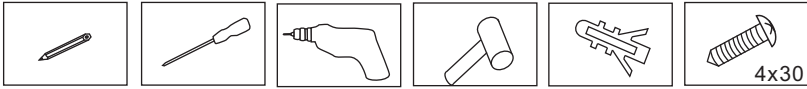

791-811(800X2000)  
 891-911(900X2000)  
 991-1011(1000X2000)  
 1091-1111(1100X2000)  
 1191-1211(1200X2000)  
 1391-1411(1400X2000)

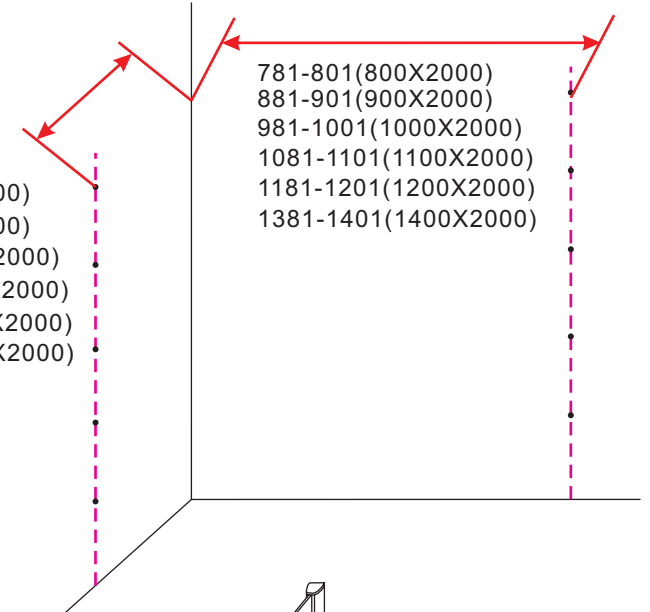

781-801(800X2000)  
 881-901(900X2000)  
 981-1001(1000X2000)  
 1081-1101(1100X2000)  
 1181-1201(1200X2000)  
 1381-1401(1400X2000)

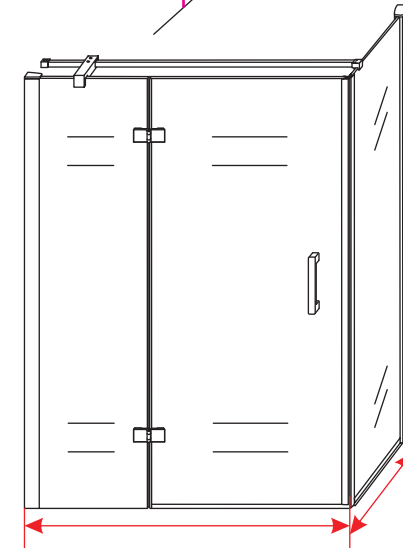

785-805(800X2000)  
 885-905(800X2000)  
 985-1005(800X2000)  
 1085-1105(800X2000)  
 1185-1205(800X2000)  
 1385-1405(800X2000)

795-815(800X2000)  
 895-915(800X2000)  
 995-1015(800X2000)  
 1095-1115(800X2000)  
 1195-1215(800X2000)  
 1395-1415(800X2000)

1. Install the wall aluminum profile, use the level ruler to make sure it vertical to the ground.

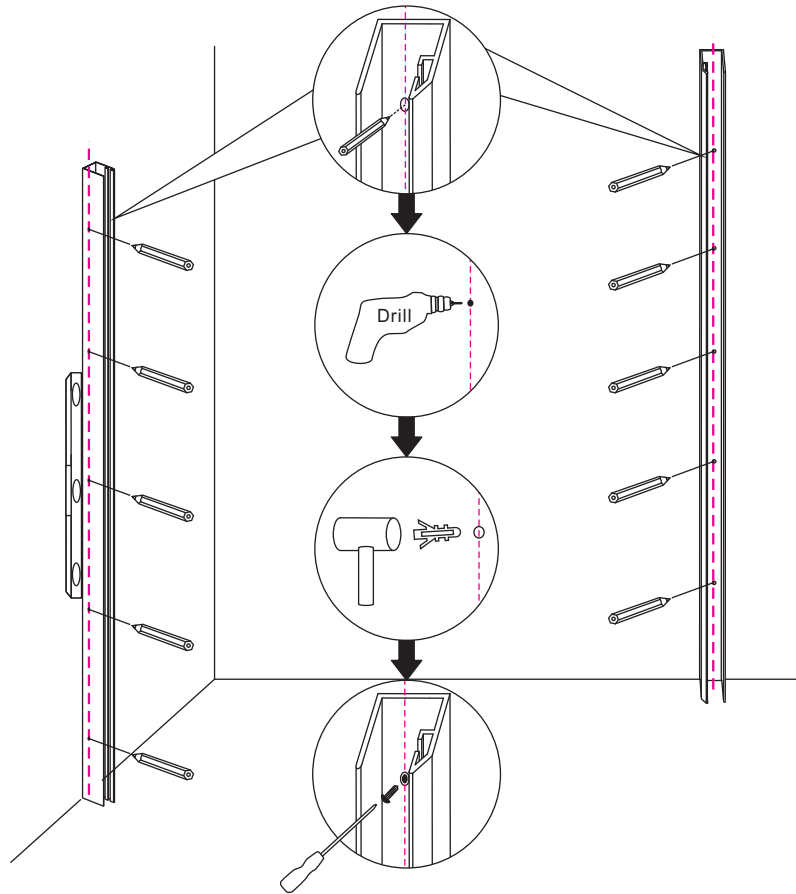
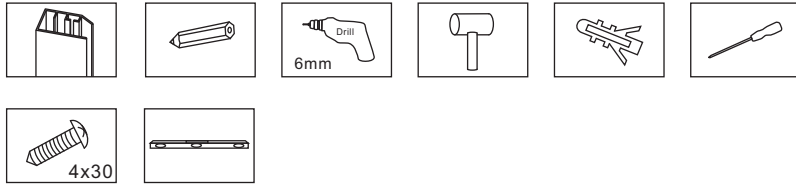

1. Use 4mm drill bit to make two holes on the aluminum and use screws to fix.
2. Install handle on the door.
3. Cover the cap for aluminum profile.

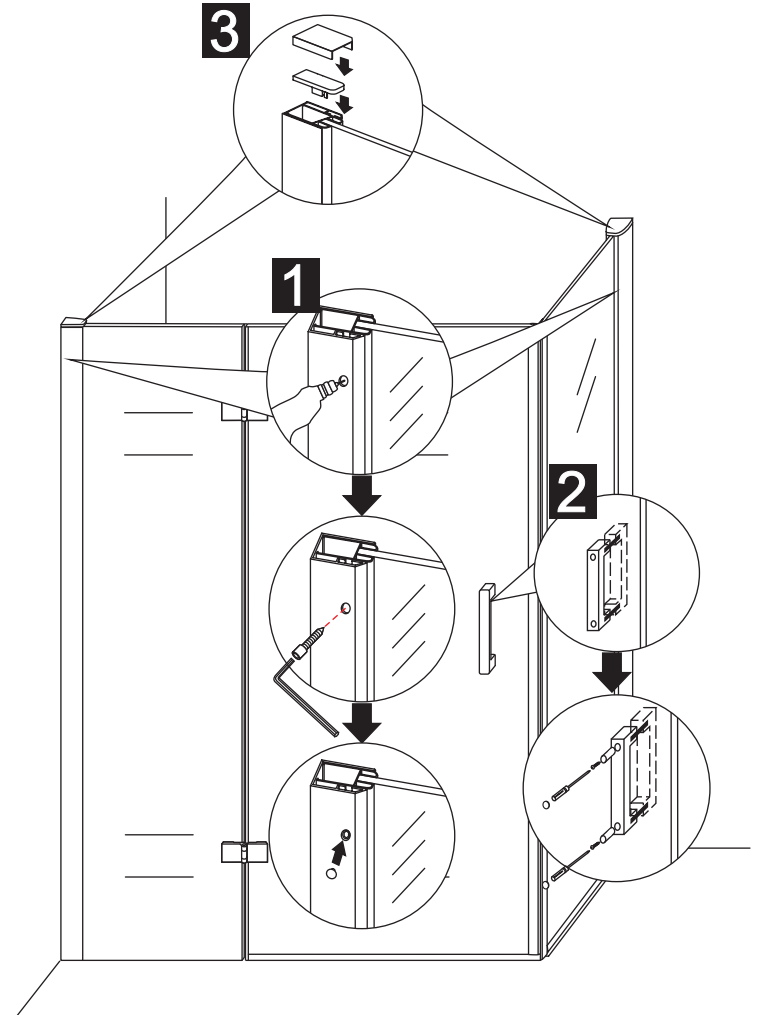

1. Install the second glass.

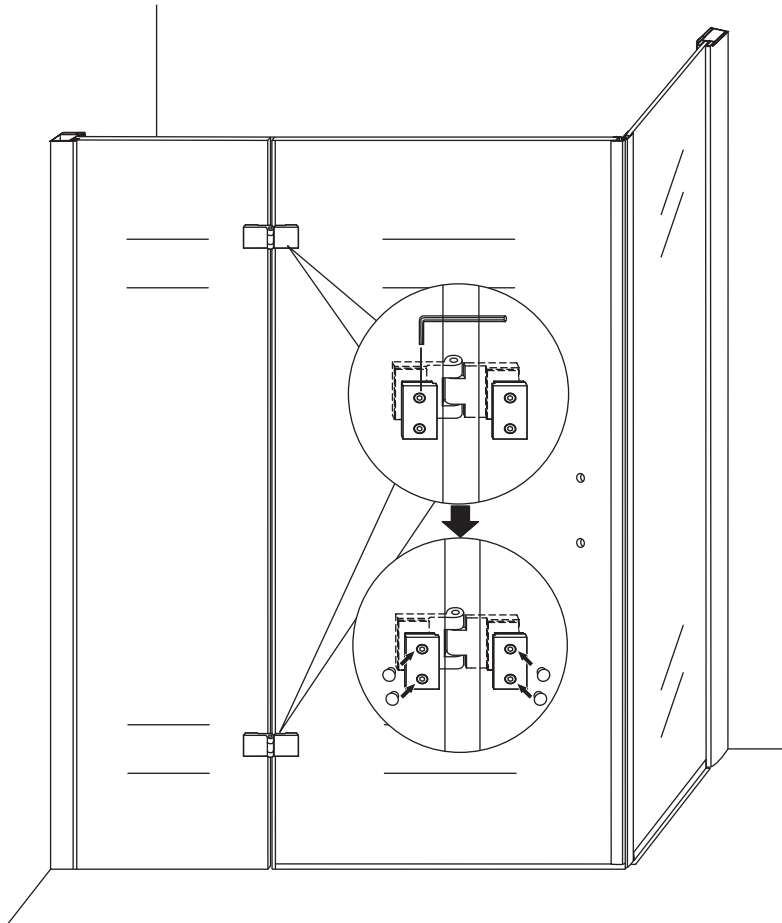
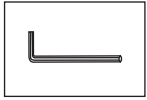

1. Insert the fixed glass into wall aluminum profile.
2. Install the magnetic gasket on the fixed glass.
3. Injection the silicon gel into the fixed glass aluminum profile then install the fixed glass into the wall aluminum profile.

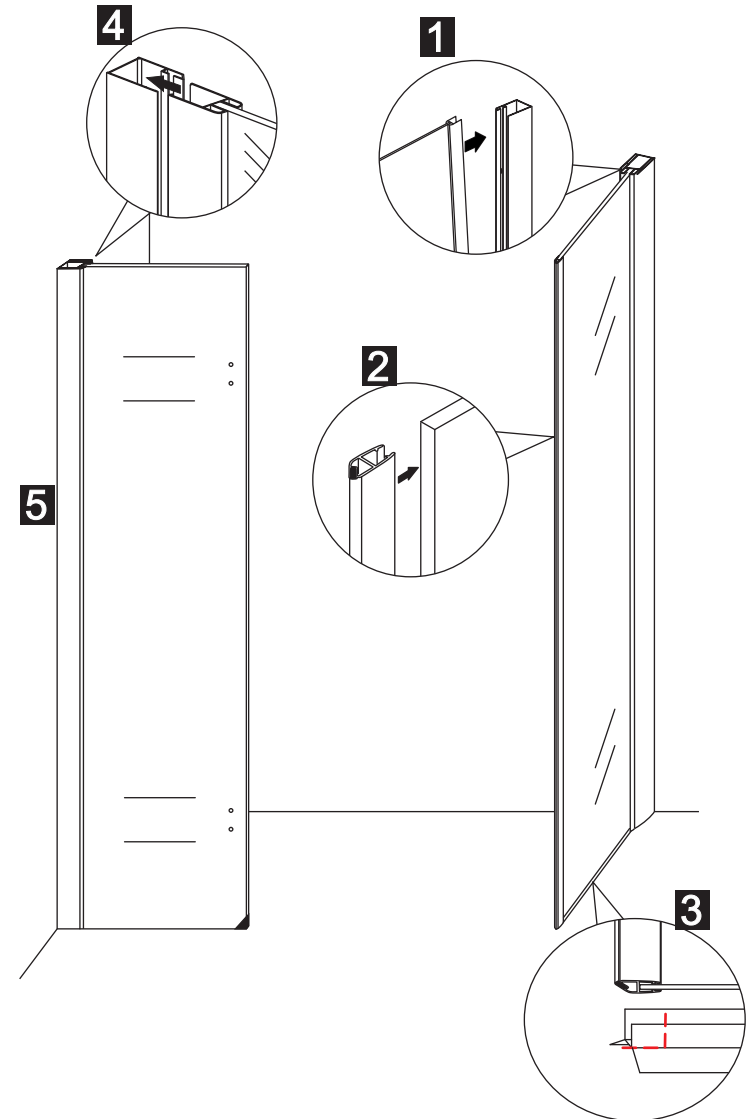
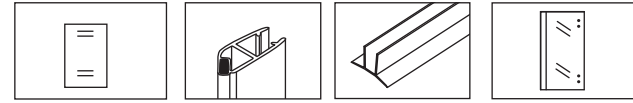

1. Install the hinge, use inner hexagon spanner fixed on the fixed door.

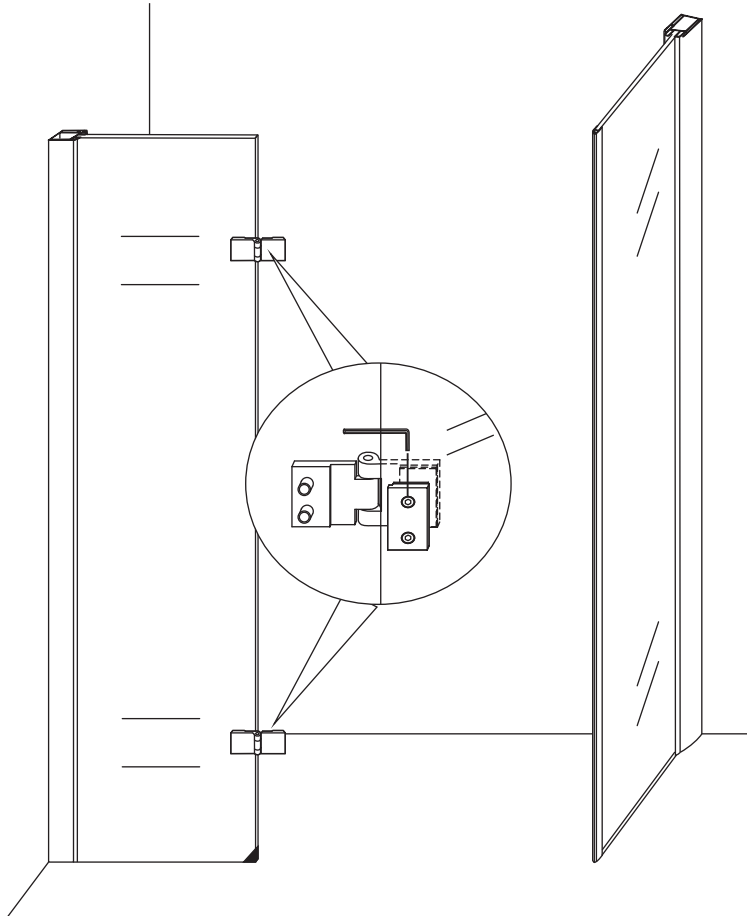
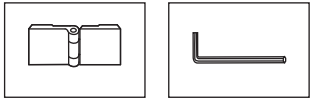

1. Cut the magnetic stripe and install

