

INSTALLATION MANUAL

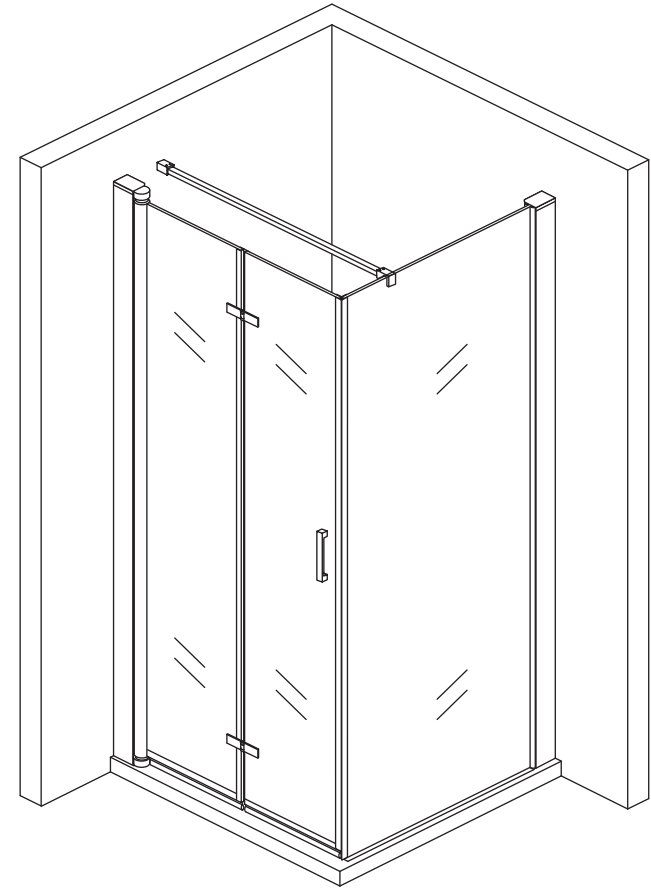

Vouwbare Nisdeur NANO 8mm

RoHS  **ISO9001:2000**

TOOL PICTURE

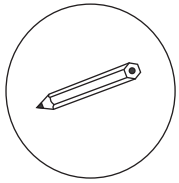

Pencil

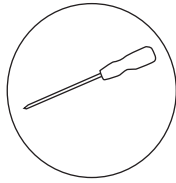

Cross screw driver

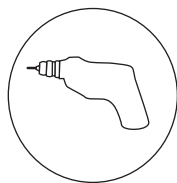

Drill machine

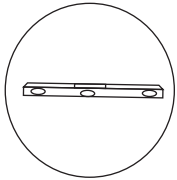

Level ruler

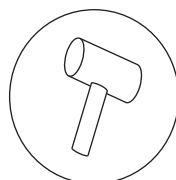

Rubber hammer

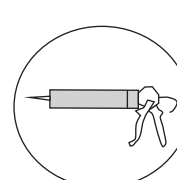

Silicon gel

Accessory list

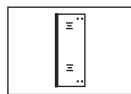

Glass

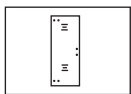

Glass



Glass

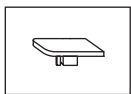

PJ-4509

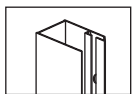

Wall profile

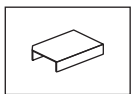

PJ-4733

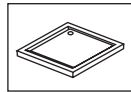

Tray

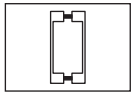

LS-1105



PJ-4577

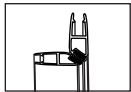

CT-6BMX90

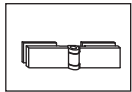

HY3109

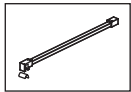

LG-2307

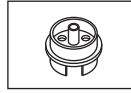

PJ-4126

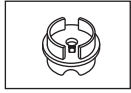

PJ-4127

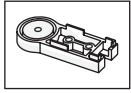

PJ-4124

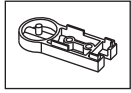

PJ-4125

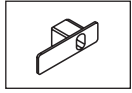

PJ-4649

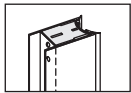

LJ-02

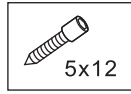

5x12

Screw

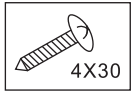

4x30

Screw

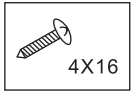

4x16

Screw

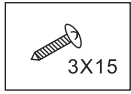

3x15

Screw

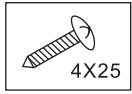

4x25

Screw

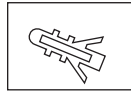

Expand tube

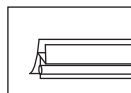

water-proof gasket

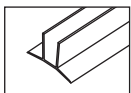

water-proof gasket

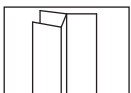

water-proof gasket

1. Install the handle on the door.
2. Install the decorative cover on the top of aluminum profile.
3. Use silicon gel to seal the gap between fixed glass and ground.

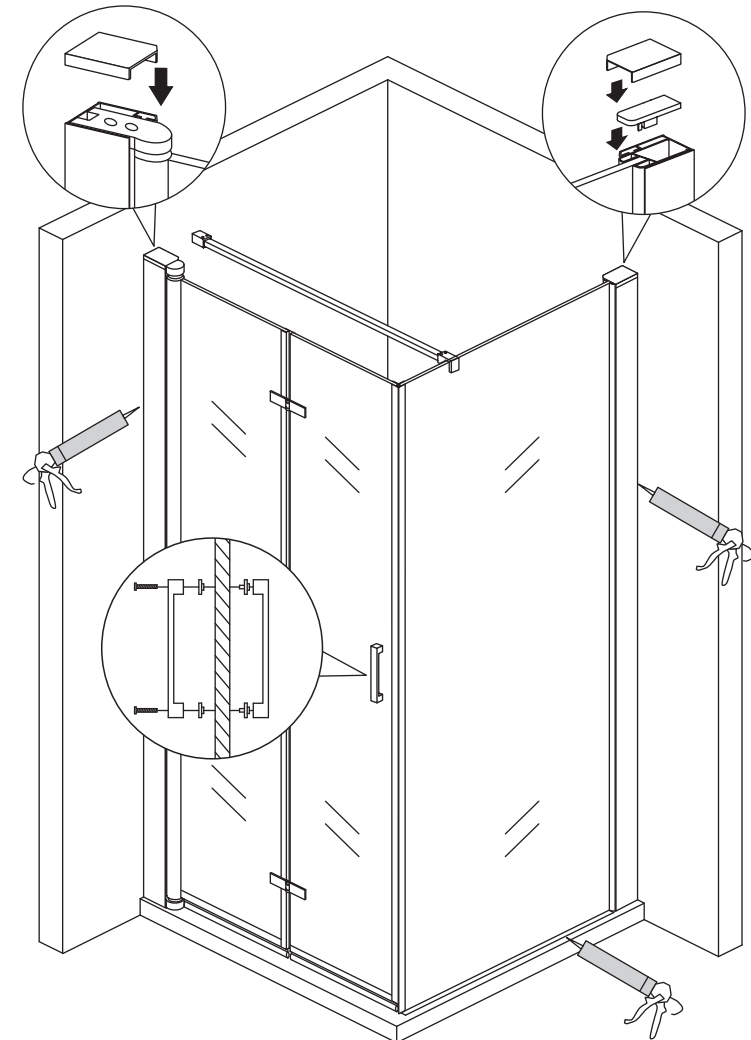
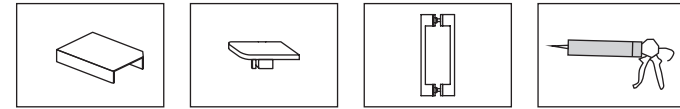

1.1. Use 4mm drill bit to make two holes on the aluminum and use screws to fix.

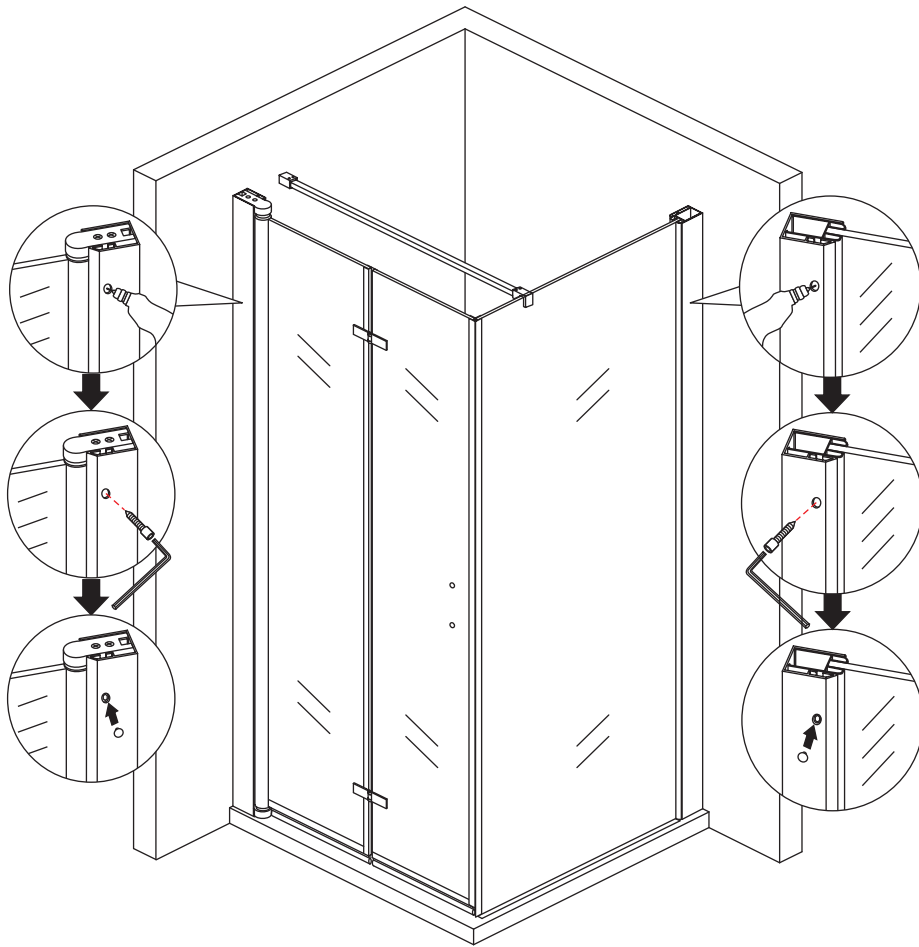
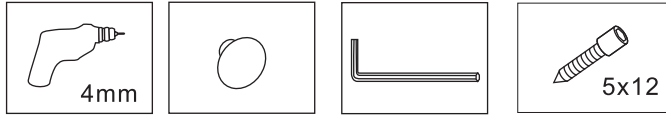

1. Place the shower tray on the installation place and use level ruler make it vertical and flat against the ground.
2. Use pencil and ruler draw the vertical installation line.

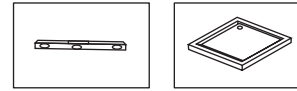

The installation size **L1** = Grootte van de Inloopdouche -25mm

The installation size **L2** = Grootte van de Vouwbare Nisdeur -25mm

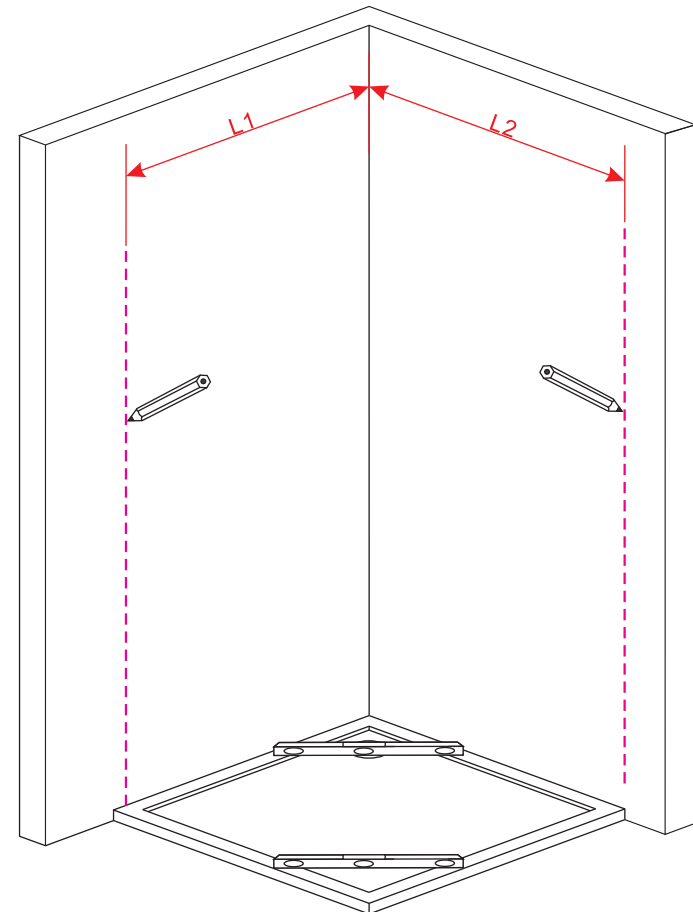

1. Put tray on the installation position.
2. Put aluminum profile on the wall and use level ruler to make it straight.
3. Use pencil draw holes on the wall.
4. Use 6mm drill bit to make holes on the wall.
5. Insert screw space pipe in the wall and screw it.

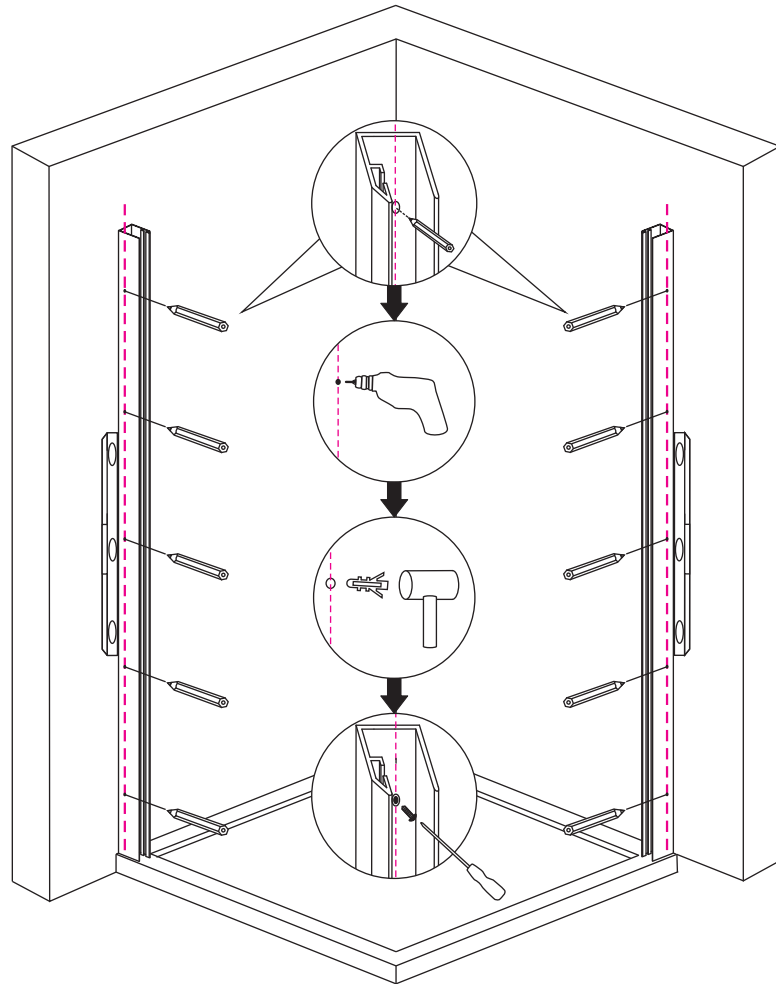
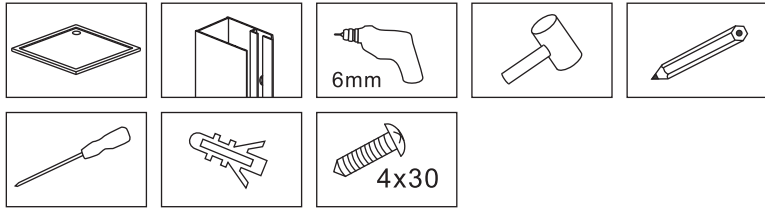

1. Fix the top support

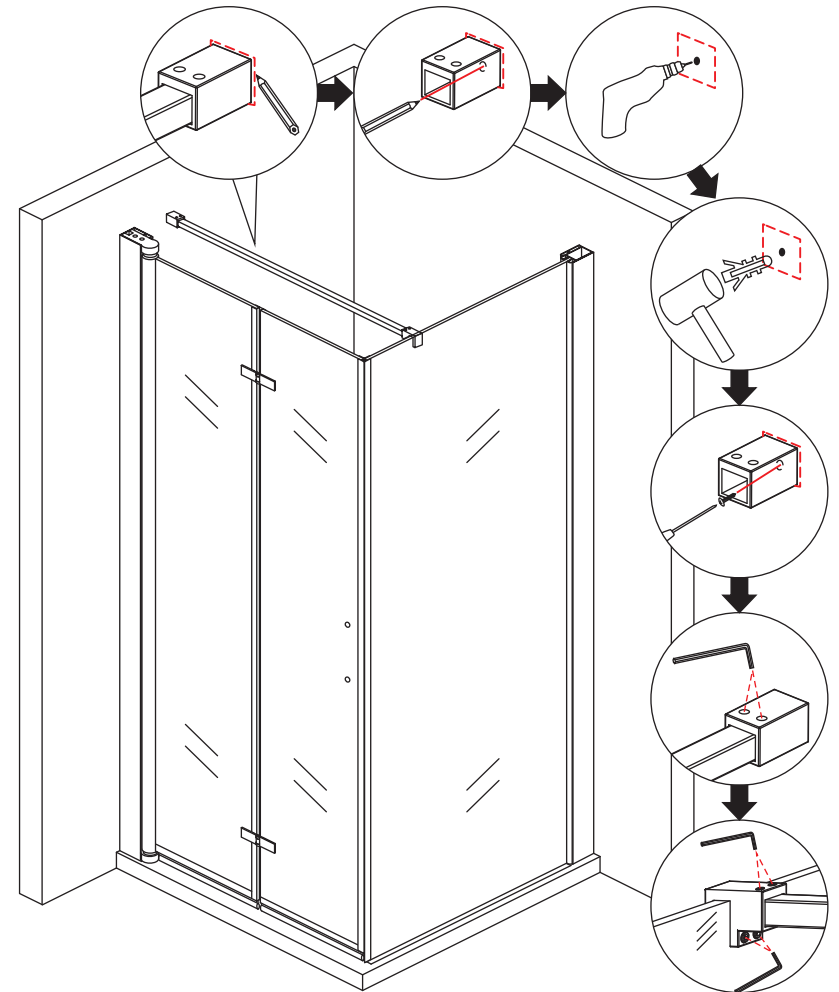
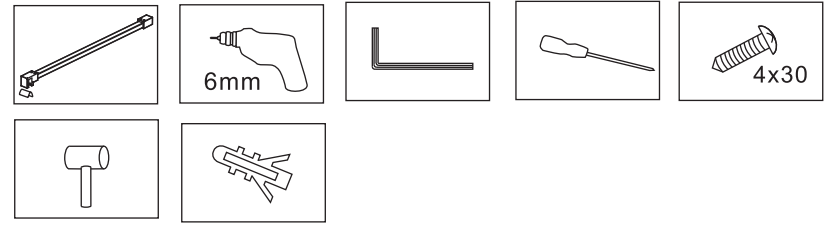

1. Insert the fixed glass into wall aluminum profile.
2. Install the magnetic gasket on the fixed glass.

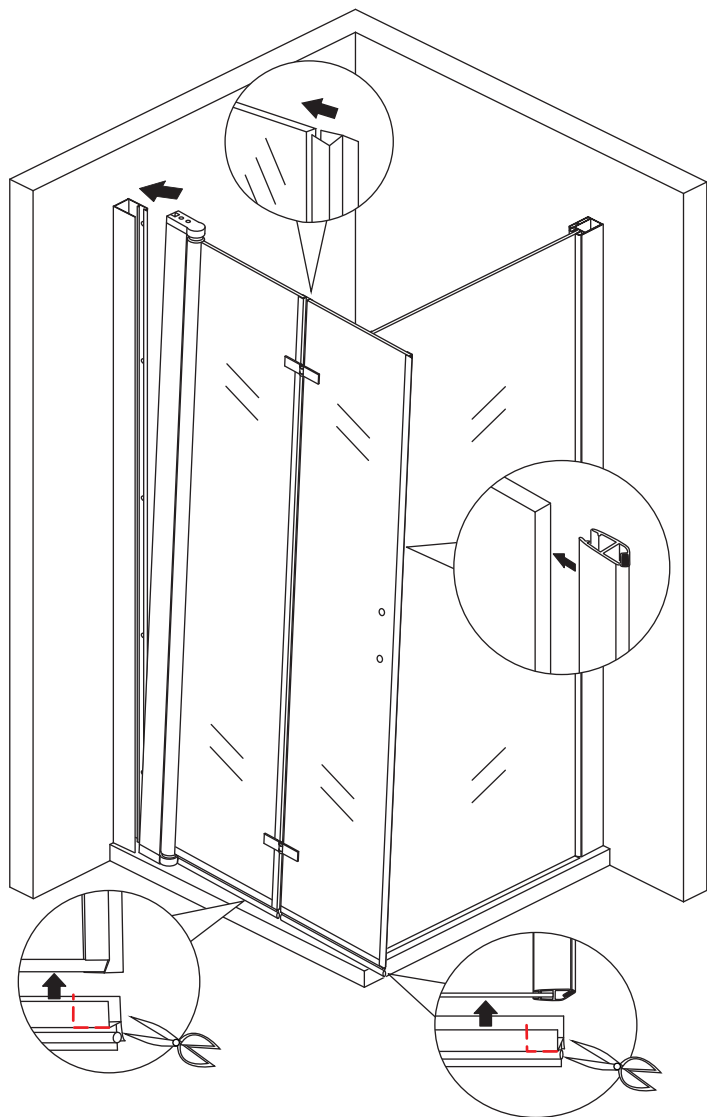
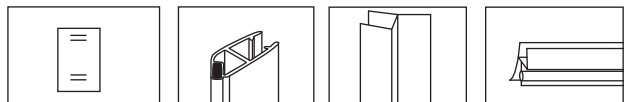

7

1. Insert the fixed glass into wall aluminum profile.
2. Install the magnetic gasket on the fixed glass.

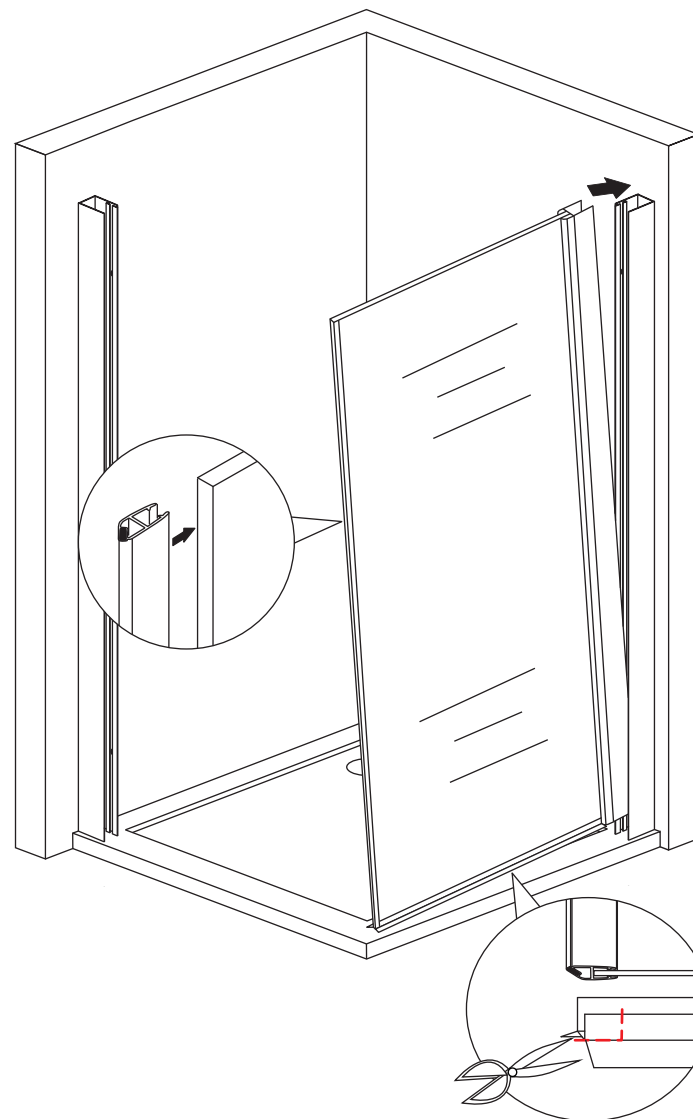
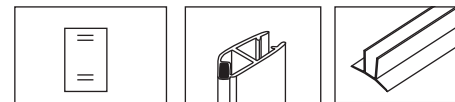

4

- 1.install the connect part on the swing profile top and bottom
- 2 .Use the zinc-alloy part connect the Swing profile and connect profile

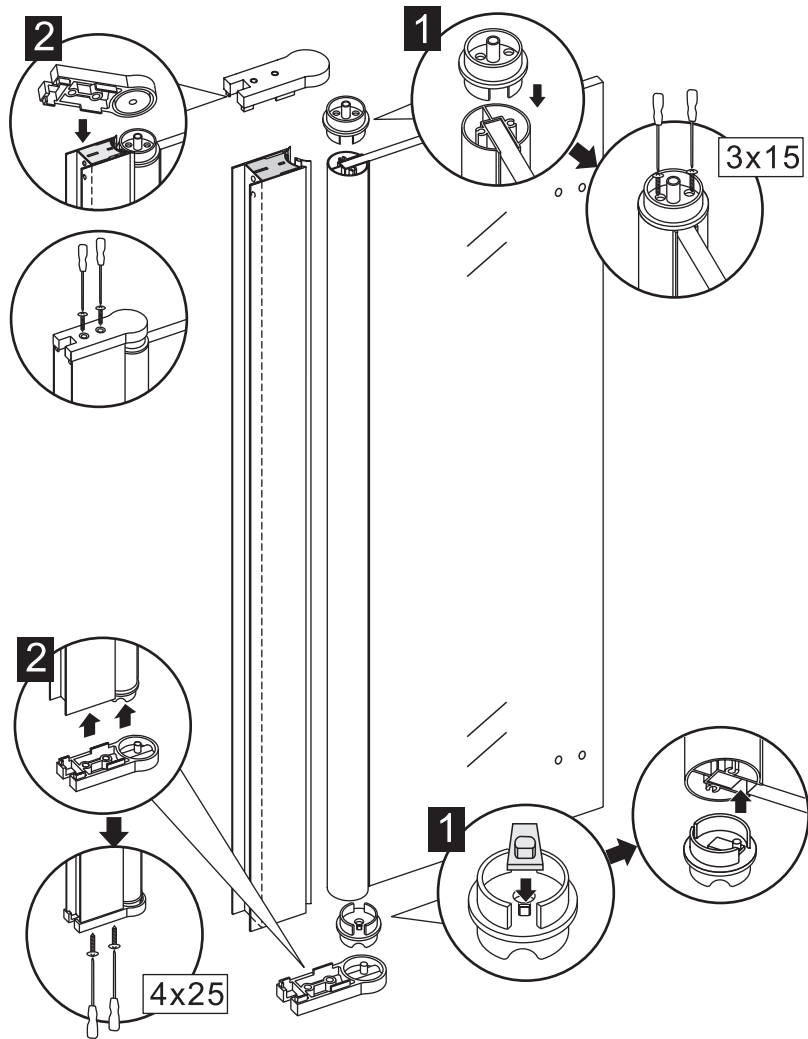
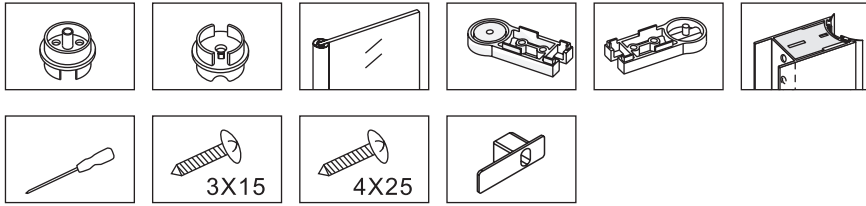

5

- 1.Use inner hexagon spanner install the hinge.

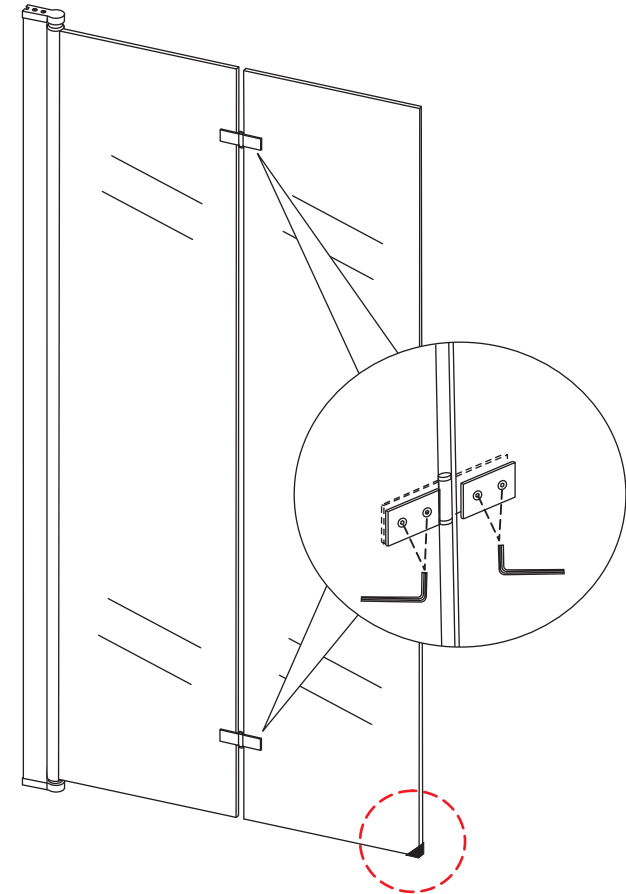
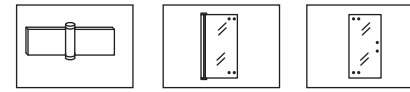

Attention: Do not remove the Black corner protector until insert well the glass into the wall profiles and fit well to prevent glass broken and splitted.



6