

Douchedeur Nisdeur Draaideur met Vaste Wand

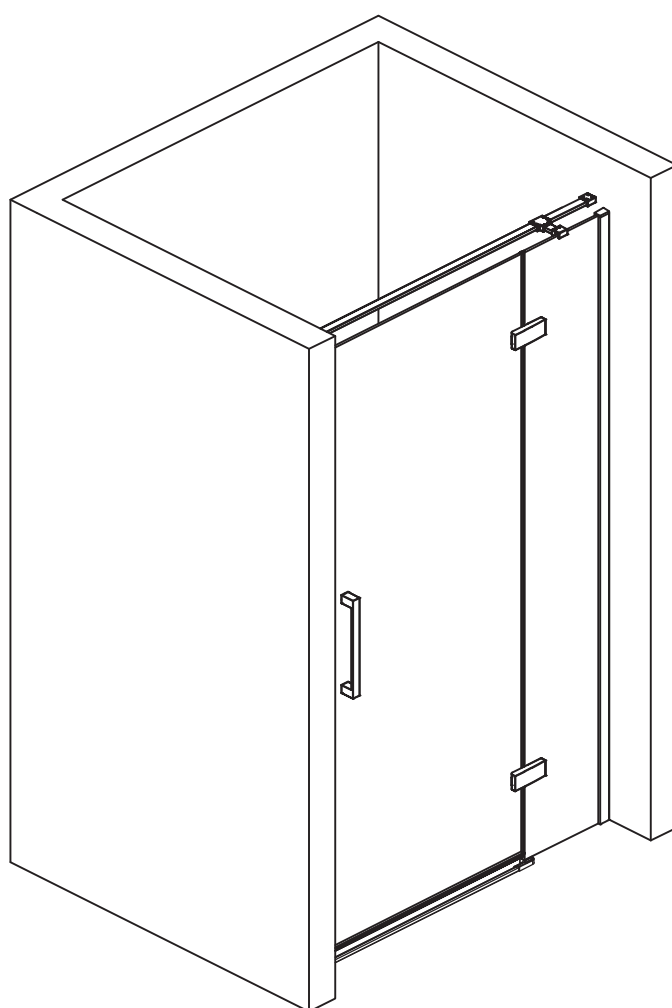

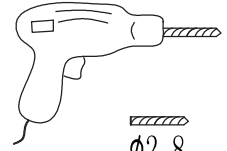

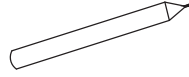

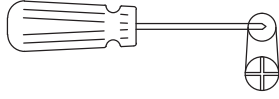
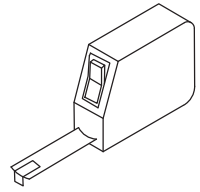
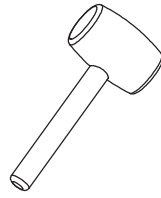
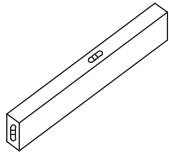
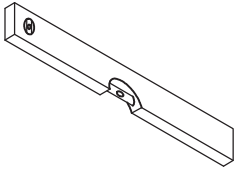



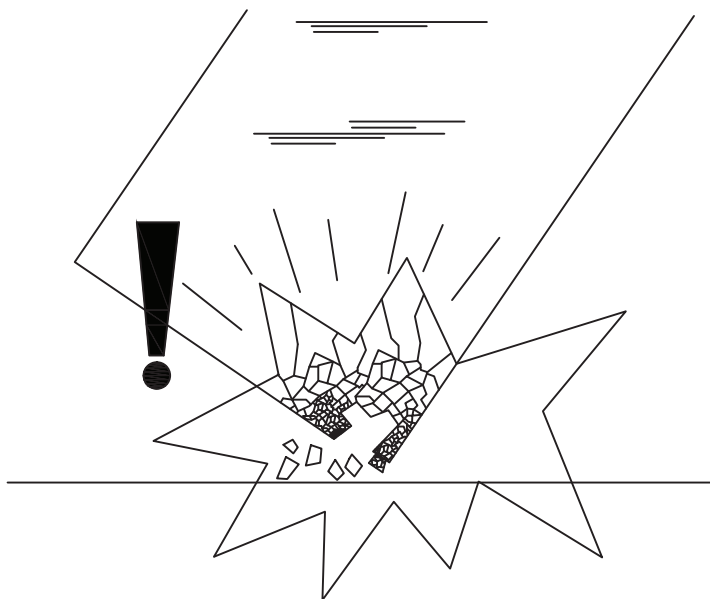
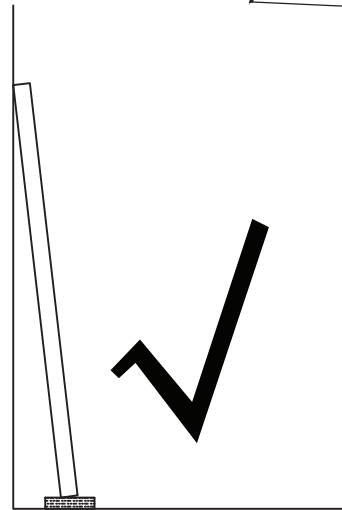
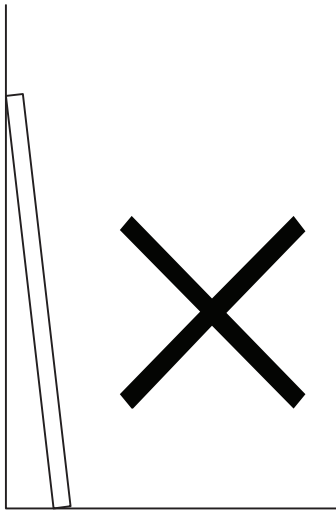
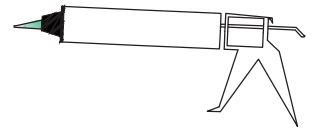

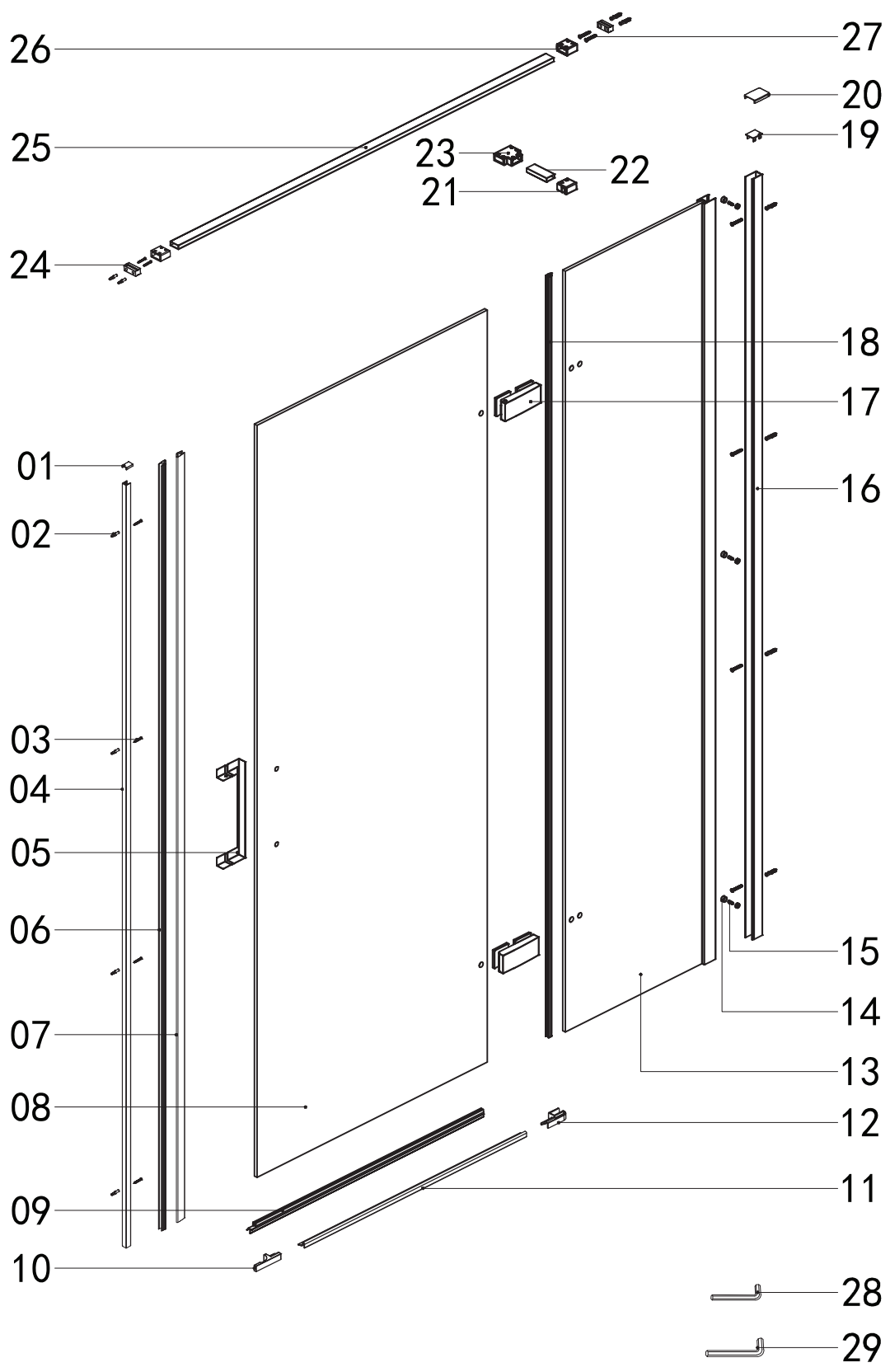





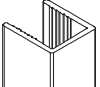

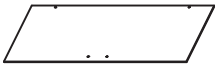

$\phi 2.8$













$\phi 6$





Nummer	Tekening	Aantal
01		1
02		12
03		8
04		1
05		1
06		1
07		1
08		1
09		1
10		2
11		1
12		2
13		1
14		3
15		3
16		1
17		2
18		1

Nummer	Tekening	Aantal
19		1
20		1
21		1
22		1
23		1
24		2
25		1
26		2
27		4
28		1
29		1

	A
200+600	790-810
300+600	890-910
400+600	990-1010
500+600	1090-1110
600+600	1190-1210
800+600	1390-1410

